

8/27/19



SOCIETY *for*
NEUROSCIENCE

*Advancing the Understanding of
the Brain and Nervous System*

*SFN Marriott Marquis
2019 Floor Plans*

Shedd AB

B70

MTE Sat 8a

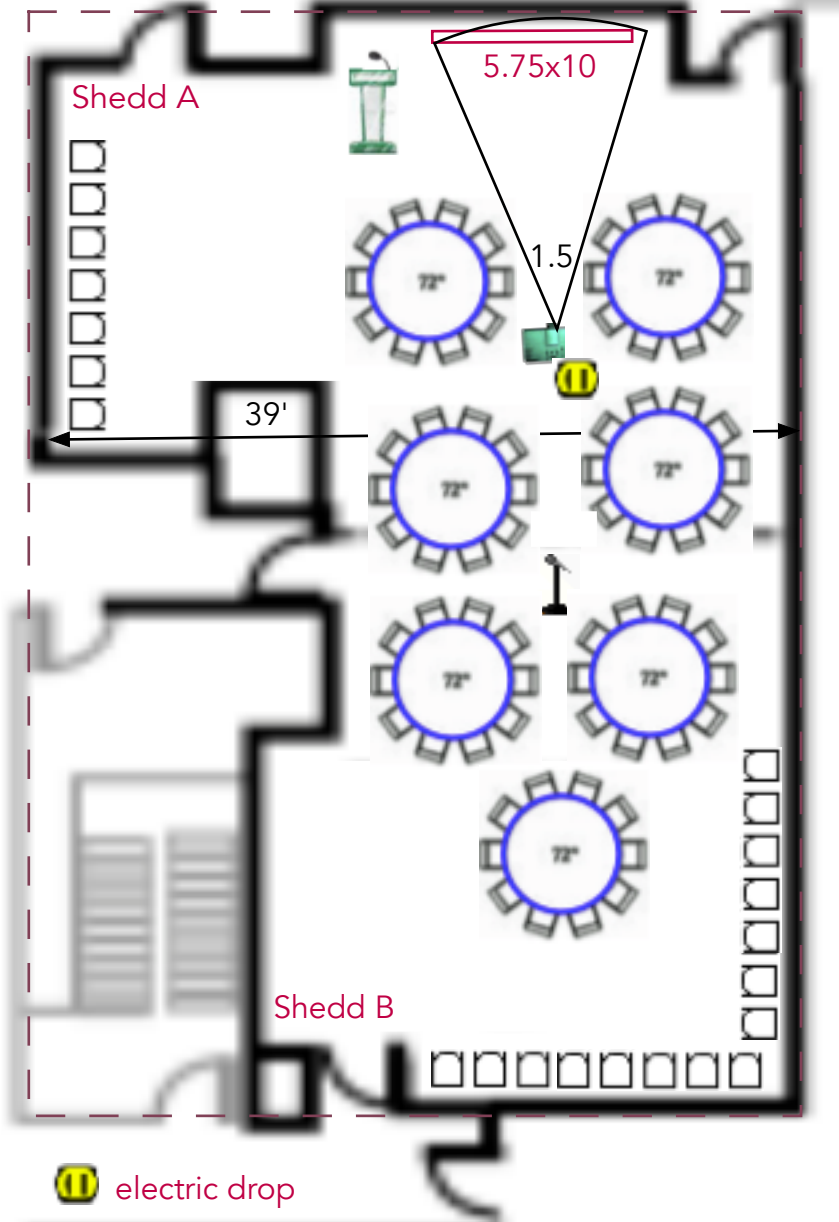

Great Lakes Ballroom A

45X63X24

B-80

MTE Sat. 8am

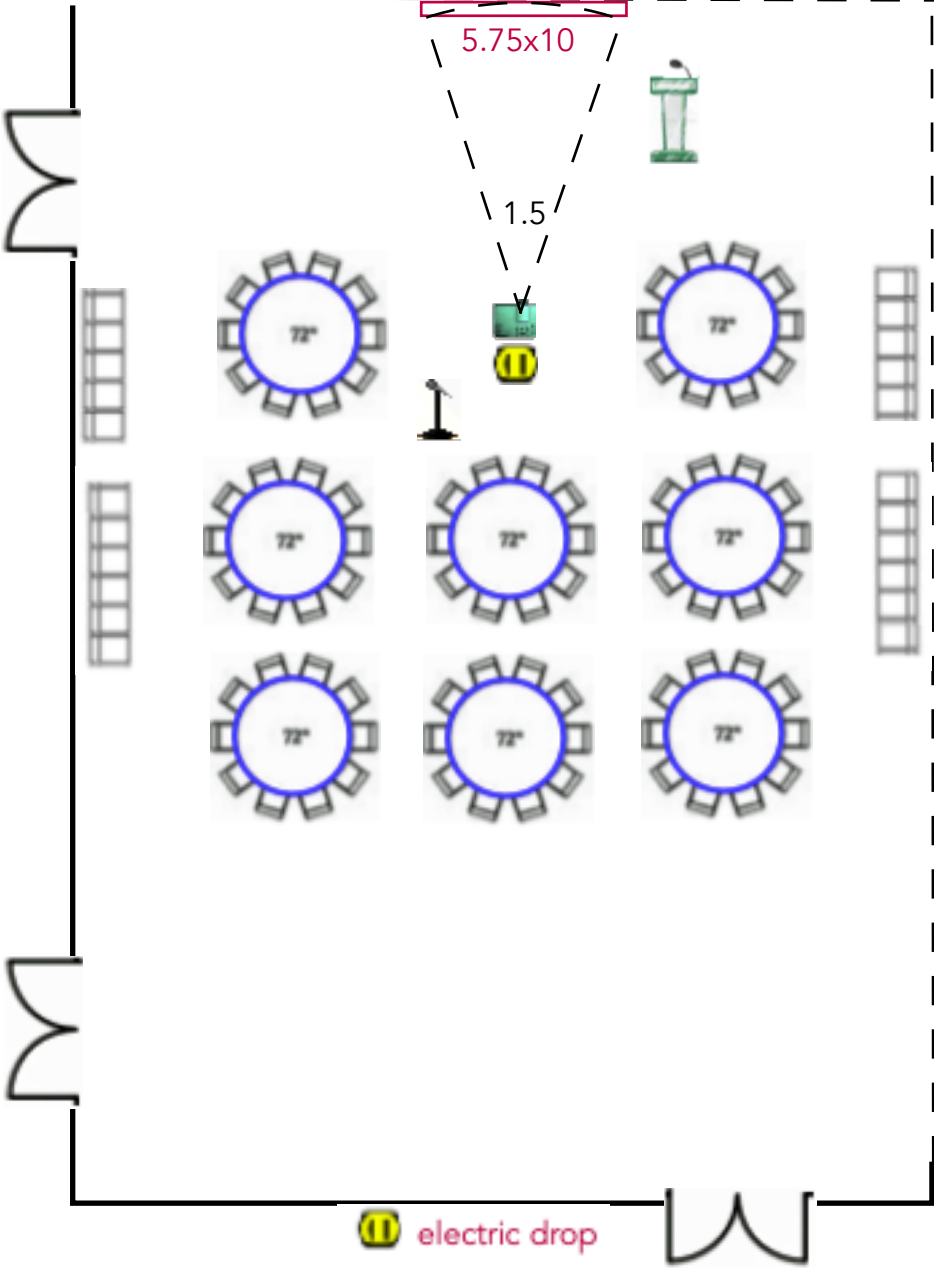

Great Lakes Ballroom B

51x63x24

B-80

MTE Sat. 8am

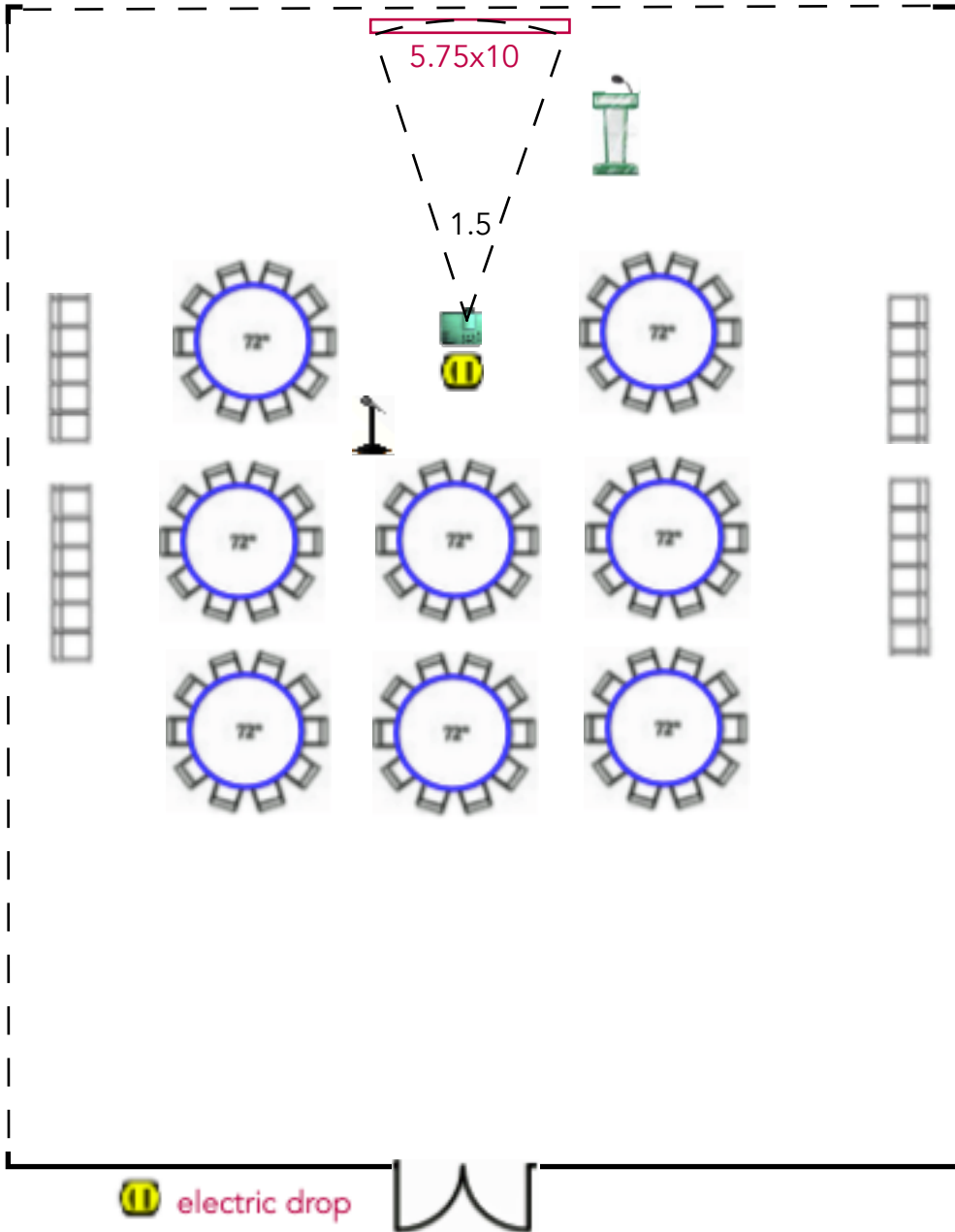

Great Lakes Ballroom C

51x63x24

B-80

MTE Sat. 8am

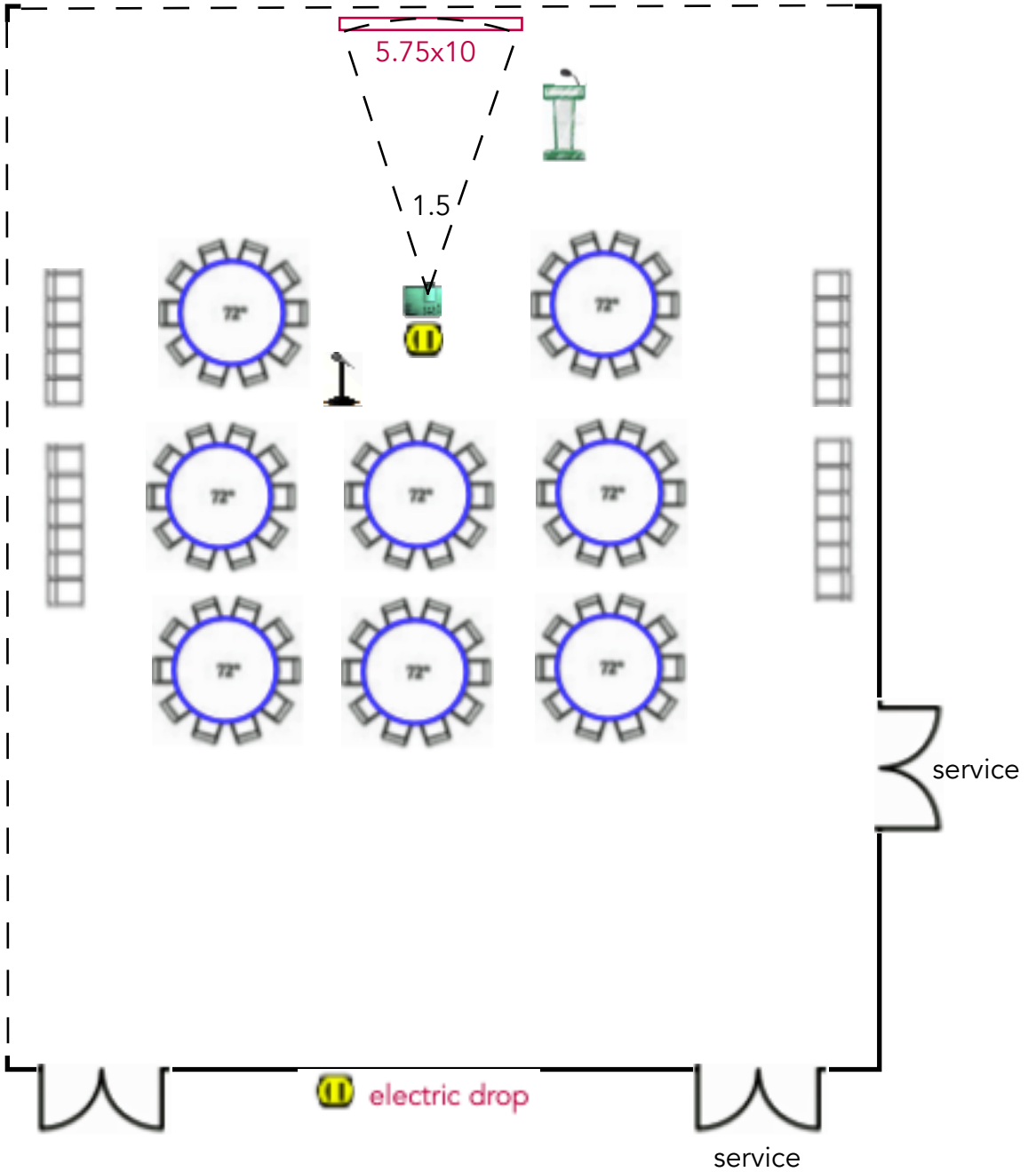

Great Lakes Ballroom E

B-80

MTE Sat. 8am

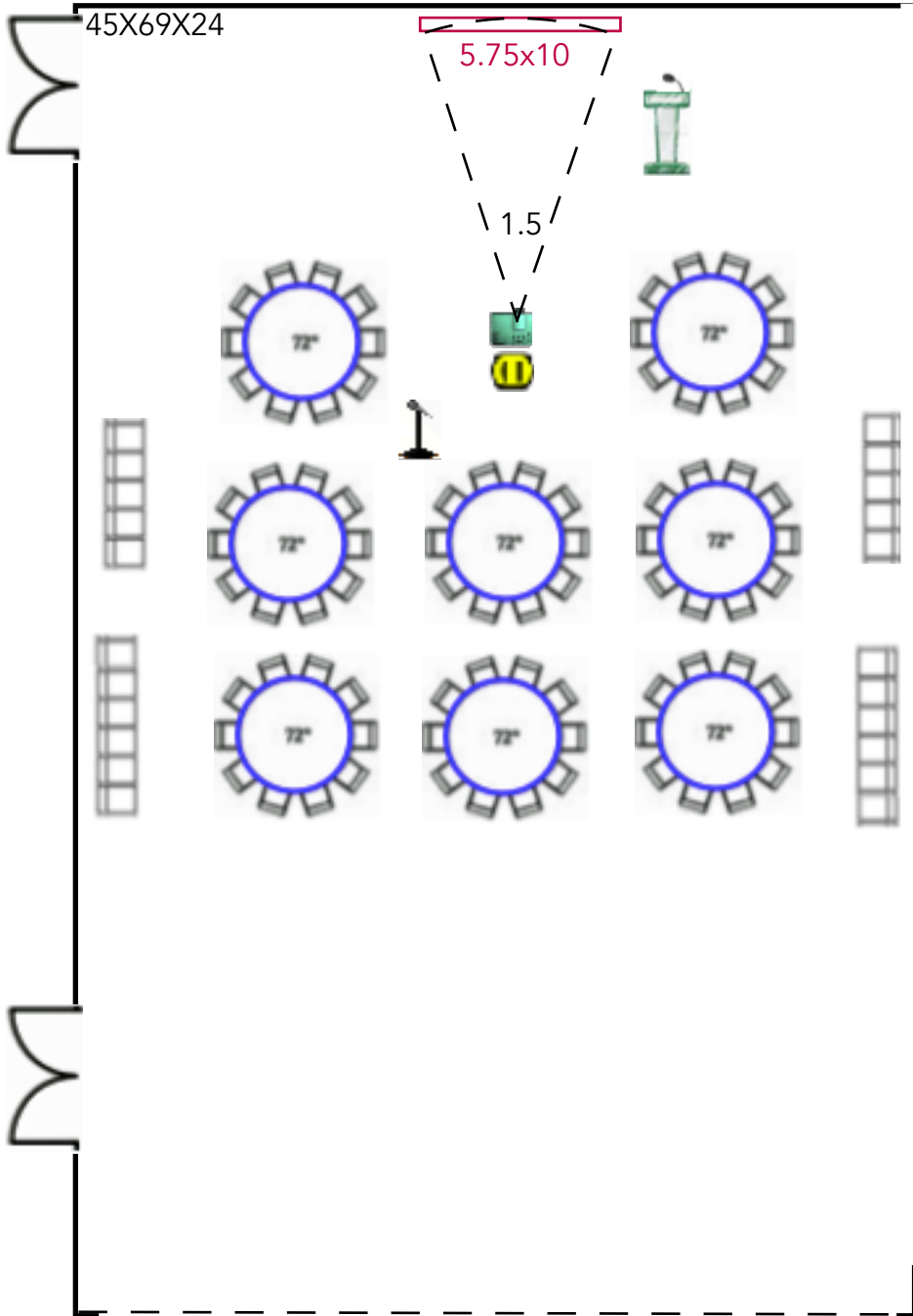

II electric drop

Great Lakes Ballroom F

B-80

MTE Sat. 8am

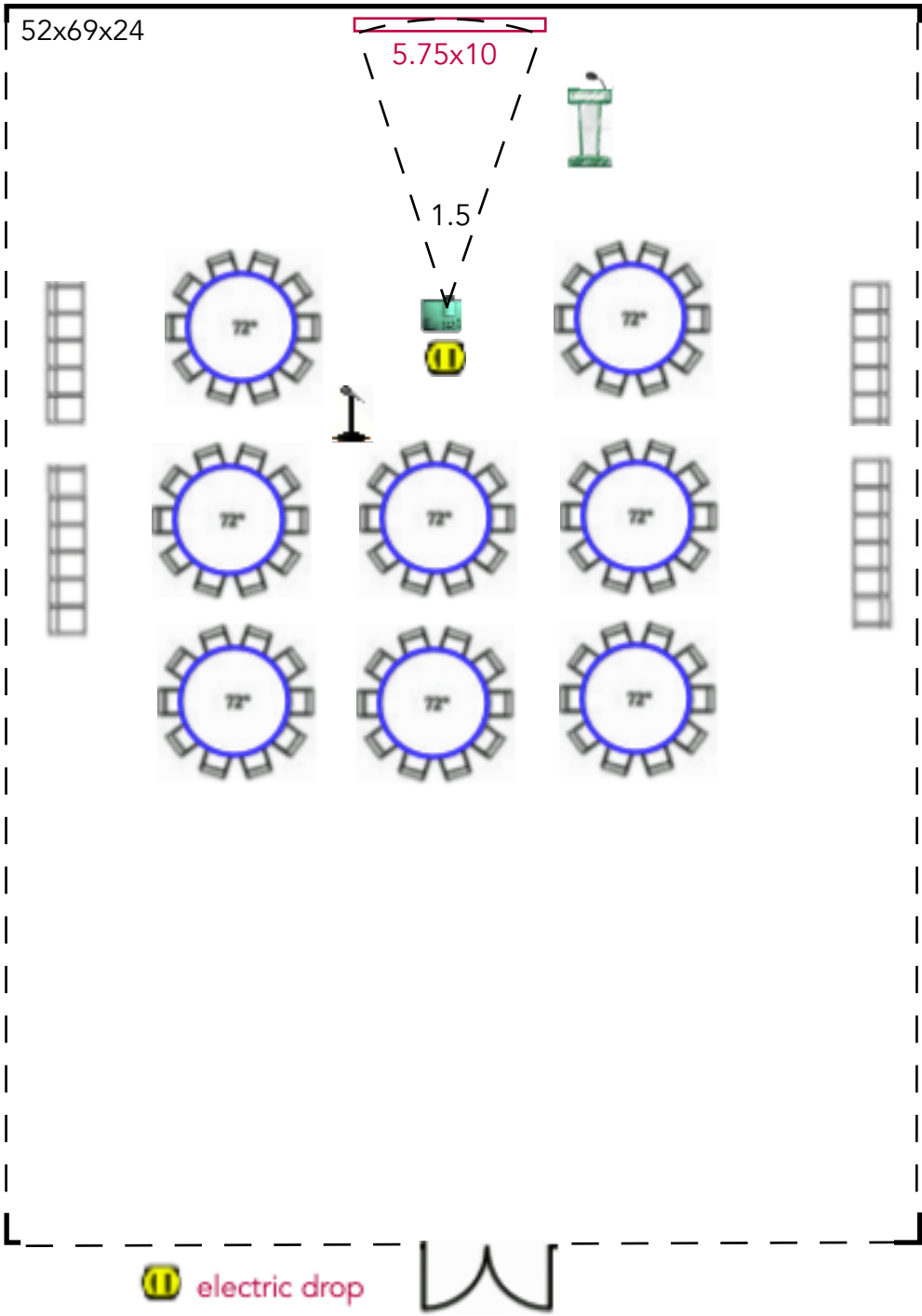

Great Lakes Ballroom G

B-80

MTE Sat. 8am

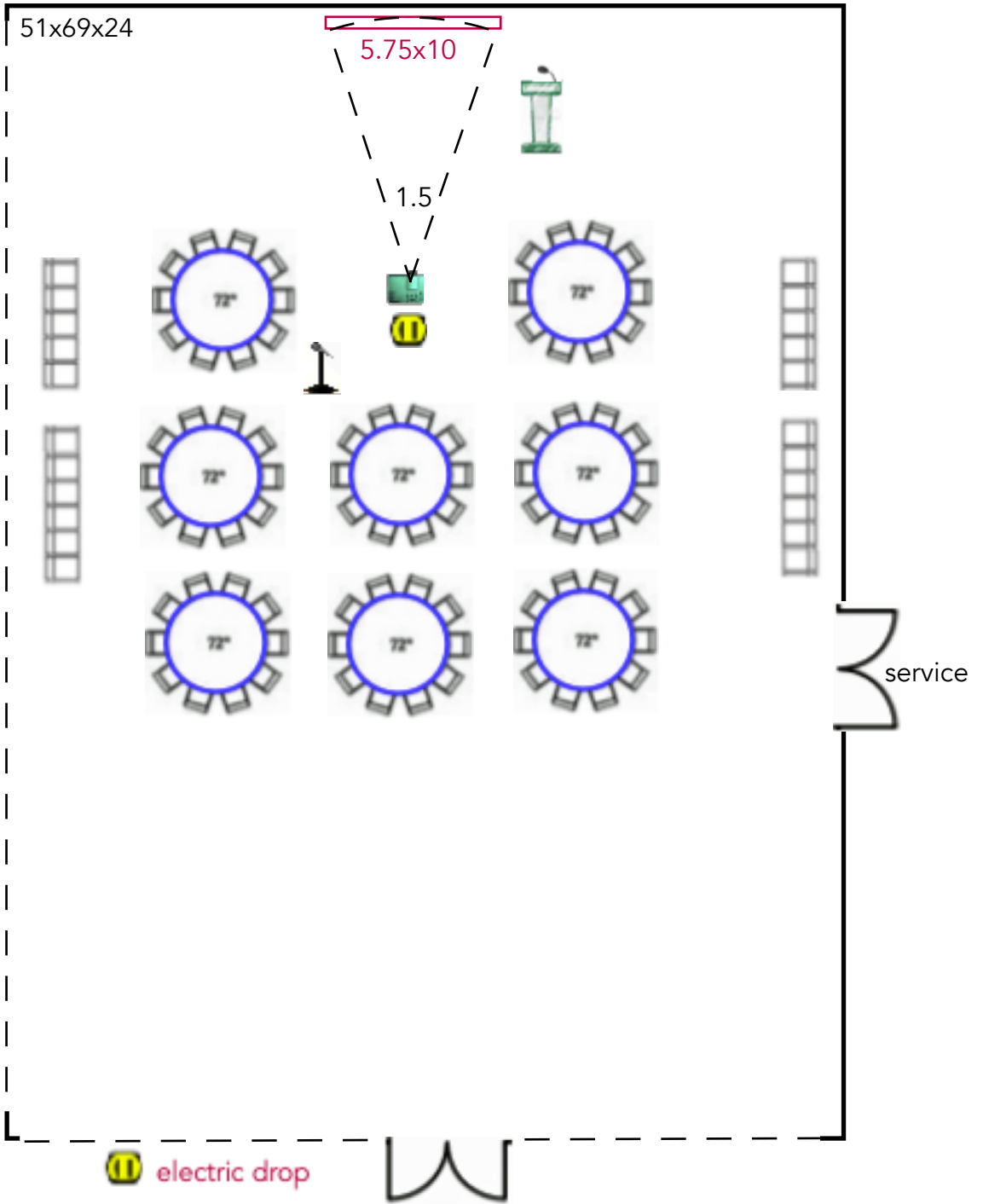

Great Lakes Ballroom AB
B-220

63x97x24

CWIN Tuesday 12p

